



扬州茂源环保科技有限公司

YANGZHOU MAOYUAN ENVIRONMENTAL PROTECTION TECHNOLOGY CO. LTD

Heat pump sludge dryer

ООО «ТИ-СИСТЕМС» ИНЖИНИРИНГ И ПОСТАВКА ТЕХНОЛОГИЧЕСКОГО ОБОРУДОВАНИЯ
Интернет: www.tisys.ru www.tisys.kz www.tisys.by www.tesec.ru www.ти-системс.пф
Телефоны: +7 (495) 7774788, 7489626, (925) 5007155, 54, 65
Эл. почта: info@tisys.ru info@tisys.kz info@tisys.by

Dryer System Composition

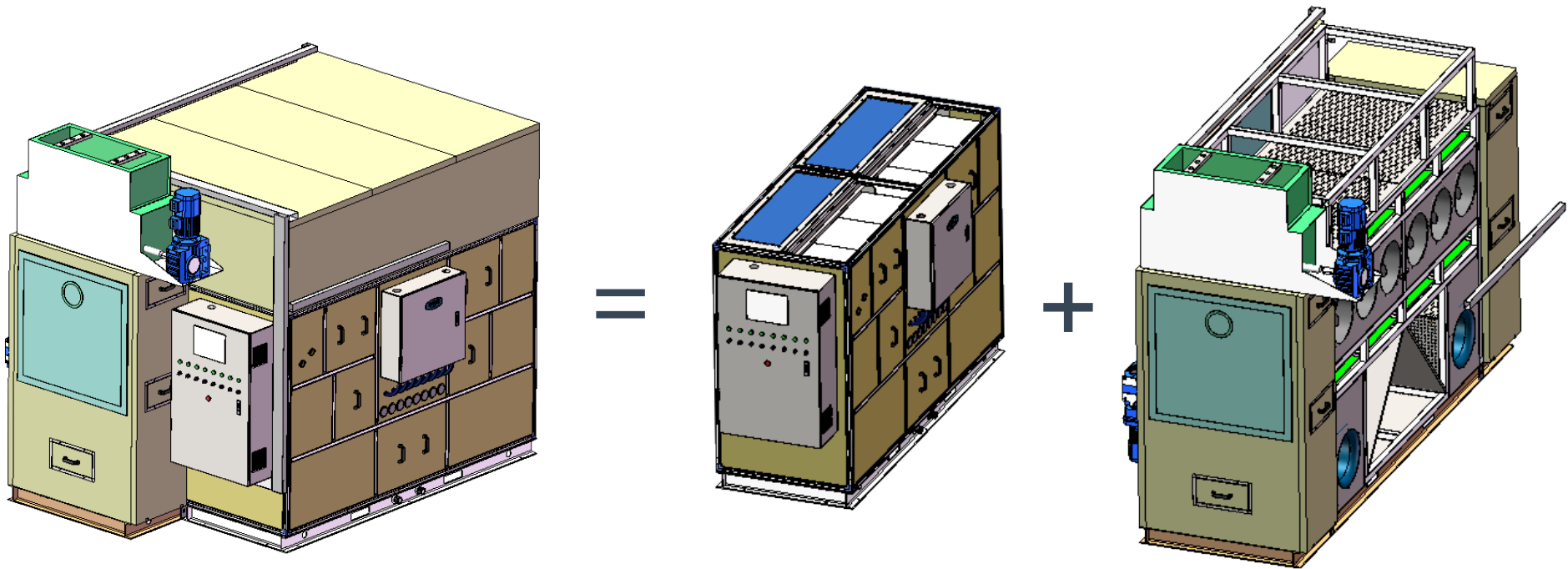

The Dryer System

Heat pump part

Belt conveying part

Heat pump part composition

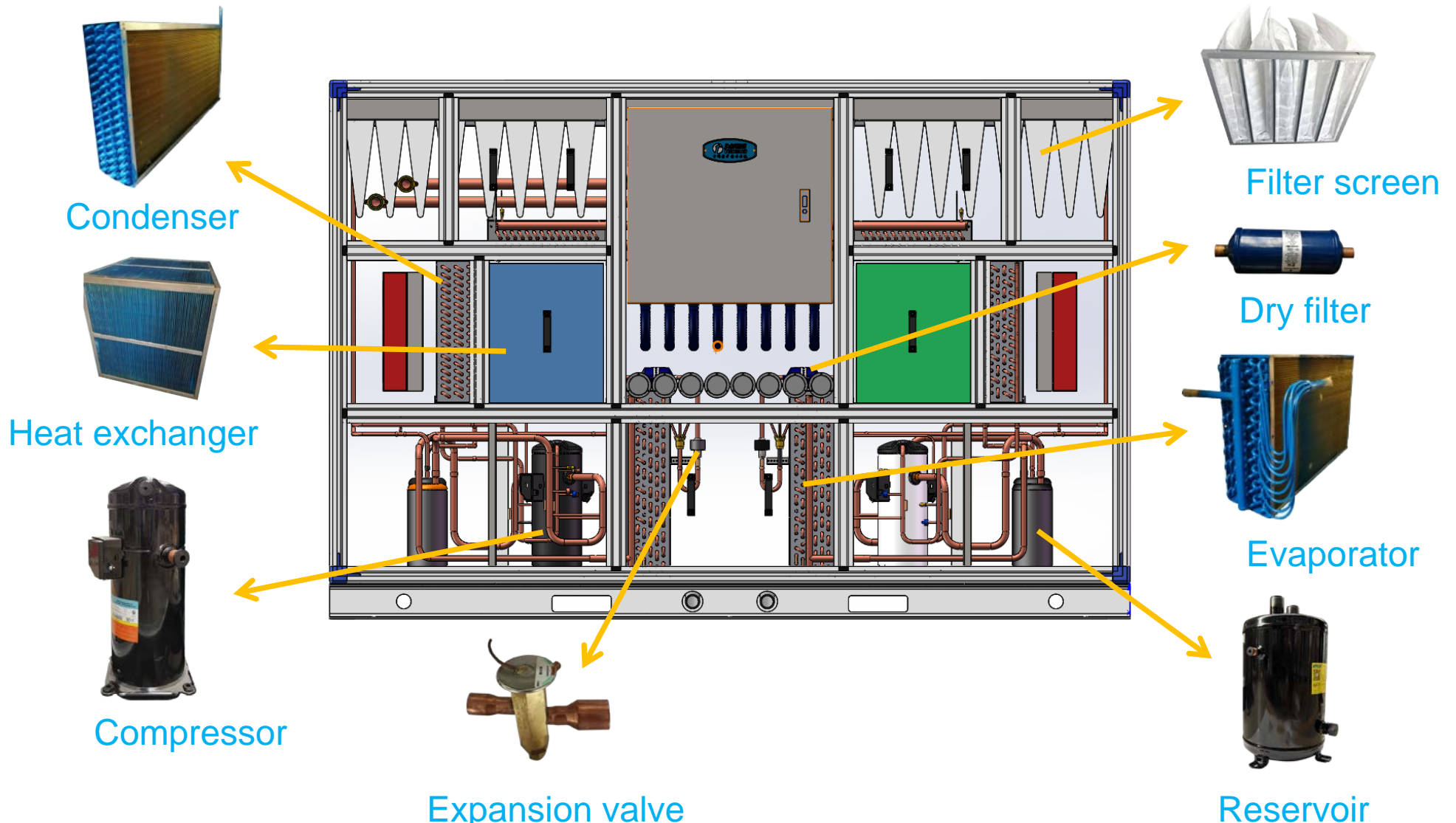

ООО «ТИ-СИСТЕМС» ИНЖИНИРИНГ И ПОСТАВКА ТЕХНОЛОГИЧЕСКОГО ОБОРУДОВАНИЯ
Интернет: www.tisys.ru www.tisys.kz www.tisys.by www.tesec.ru www.ти-системс.рф
Телефоны: +7 (495) 7774788, 7489626, (925) 5007155, 54, 65
Эл. почта: info@tisys.ru info@tisys.kz info@tisys.by

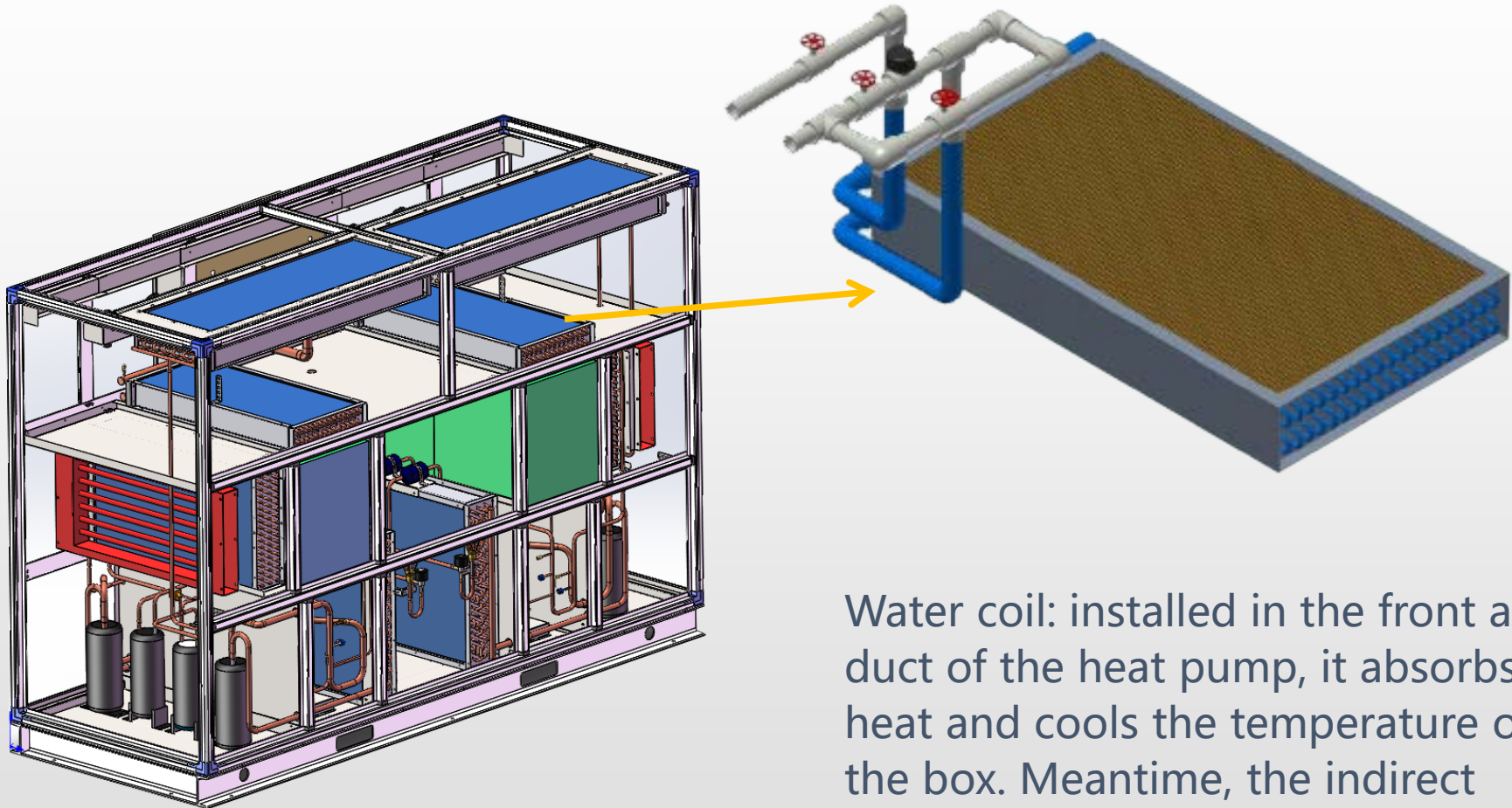

Water coil: installed in the front air duct of the heat pump, it absorbs heat and cools the temperature of the box. Meantime, the indirect contact between the cold source and the heat source can also achieve a certain dehumidification effect.

Four effect dehumidification definition

The air is cooled and dehumidified through water coil, plate fin heat exchanger and two-stage evaporator; The two-stage evaporator adopts series cooling, which is more suitable for high temperature and low humidity air treatment. The dew point temperature drops by 6-14 °C. The two-stage evaporator (two independent refrigeration systems) can work independently.

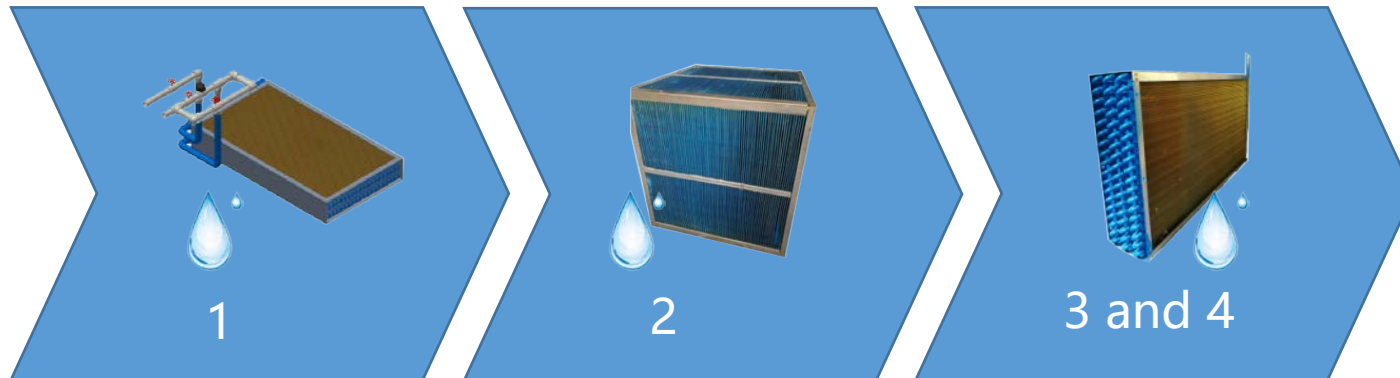

The dehumidification heat recovery cycle is to add a heat exchanger in the dehumidification heat pump to reduce the temperature of the air entering the evaporator and increase the temperature of the air entering the condenser; The regenerative cycle makes the evaporator cooling capacity used for air cooling reduce (invalid cooling process), while the cooling capacity used for cooling and dehumidification process increases, making the optimal evaporation temperature and optimal dehumidification capacity of heat pump drying increase; The dehumidification heat pump with regenerative cycle can save more than 30% energy than the ordinary heat pump.

ООО «ТИ СИСТЕМС» ИНЖИНИРИНГ И ПОСТАВКА ТЕХНОЛОГИЧЕСКОГО ОБОРУДОВАНИЯ
Интернет: www.tisys.ru www.tisys.kz www.tisys.by www.tesec.ru www.ти-системс.рф

Телефоны: +7 (495) 7774788, 7489626, (925) 5007155, 54, 65

Эл. почта: info@tisys.ru info@tisys.kz info@tisys.by

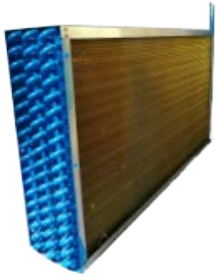

The condenser is one of the four major of the refrigeration system; The refrigerant gas with high temperature and pressure is converted into liquid, and the heat in the pipe is transferred to the nearby air. The working process of condenser is an exothermic process. (Heating process)

Evaporator, one of the four major components of the refrigeration system; The refrigerant liquid with low temperature and low pressure is heat exchanged with the outside air through the evaporator to vaporize and absorb heat. The working process of evaporator is heat absorption process. (Refrigeration process)



Reservoir, auxiliary of refrigeration system; The function is to separate the refrigerant that has not been evaporated, so as to prevent the liquid hammer caused by the refrigerant liquid entering the press.

Dry filter, auxiliary of refrigeration system; Its function is to absorb water in the refrigeration system, block impurities in the system so that it cannot pass through, and prevent ice blockage and dirt blockage of the refrigeration system pipeline.



One of the four major of the refrigeration system; The function is to compress the low temperature and low pressure gas into the high temperature and high pressure gas and send it to the condenser .

The special structure of the heat exchanger makes the cold air and hot air not interfere with each other in a limited space and distinguishes them. At the same time, the indirect contact between cold air and hot air also plays a part in dehumidification.

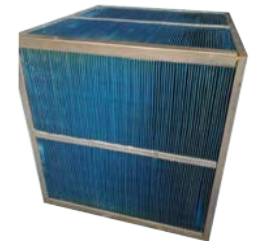

Expansion valve, one of the four major of the refrigeration system; The refrigerant liquid with high temperature and pressure becomes the gas with low temperature and pressure after being throttled by the expansion valve.

When the ambient temperature is low, the electric heating shall preheat the equipment, and it shall not be closed until the temperature reaches the set value. Provide a good operating environment for the refrigeration system of the equipment.



Belt conveying part

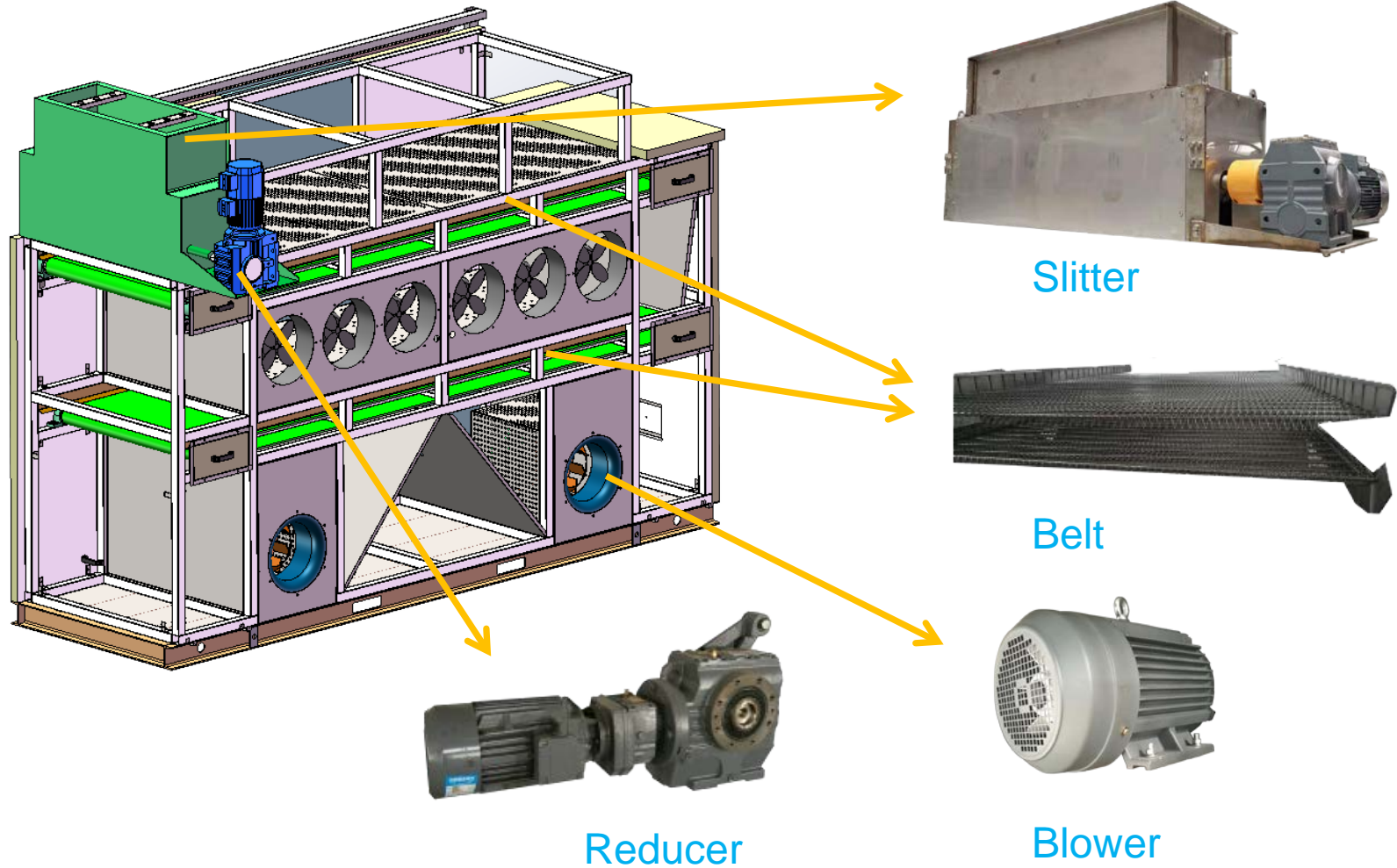



The mesh belt is made of stainless steel mesh with a layer of polyester mesh on its surface. As the sludge changes in quality and shape during mesh belt drying, the polyester mesh of all upper mesh belts is slightly larger than that of lower mesh belts.

When the air circulates in the compartment, it filters out the impurities contained in the gas to prevent the refrigeration system components from running smoothly due to blockage.



Reducer drives the mesh belt to operate, ensuring normal operation under the condition of low speed and large torque. The mesh belt motor can be variable-frequency, and the frequency can be adjusted as required.

The fan faces the condenser, blows out its heat, and heats the materials on the mesh belt.



The slitter cuts the mud cake into clear mud strips, and the formed sludge is easier to dry.

Refrigeration system

Refrigeration system: composed of compressor, condenser, expansion valve, evaporator, auxiliary drying filter, liquid storage tank and gas-liquid separator. The pipes between them are connected in turn to form a closed system. The refrigerant continuously circulates in the system, changes its state, and exchanges heat with the atmosphere.

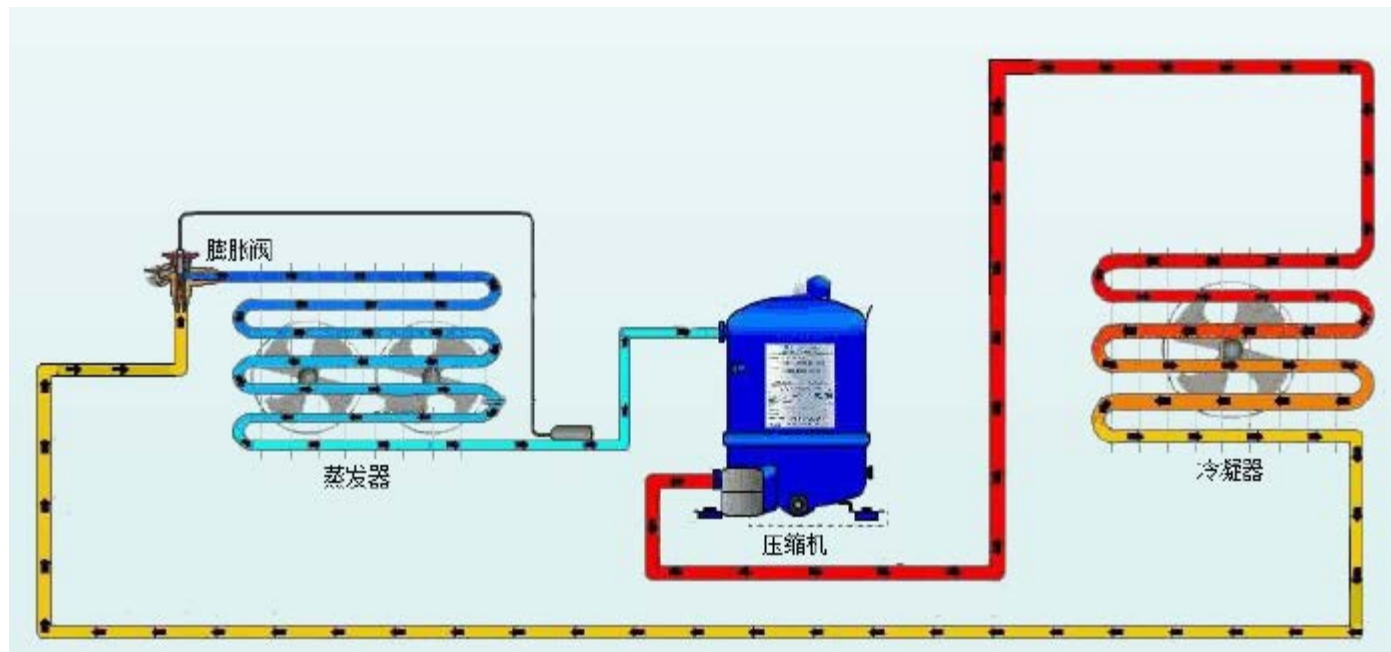

Refrigeration principle: The compressor compresses the refrigerant air with a lower pressure into a air with a higher pressure, raises the pressure and sends it to the condenser, where it condenses into a liquid with a higher pressure (exothermic, heating process), after being throttled by the expansion valve, it becomes a liquid with a lower pressure, and then is sent to the evaporator, where it evaporates and becomes a gas with a lower pressure (heat absorption, refrigeration process), and then sent to the inlet of the compressor, thereby Complete the refrigeration cycle.

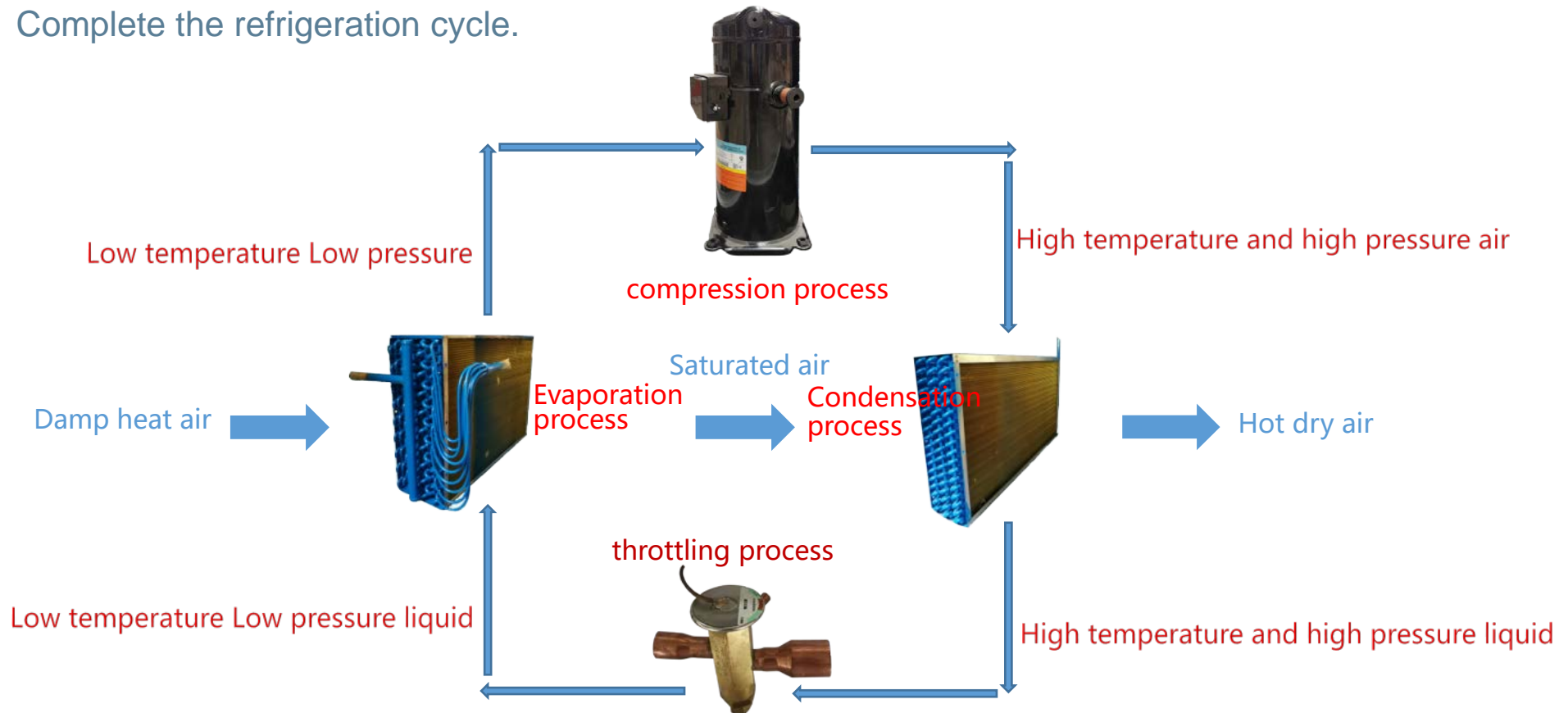

Belt conveying part

The mechanical transmission consists of a feeder, a slitter, an upper mesh belt, a lower mesh belt, and a discharger. Workflow: The feeder transports the material to the feed hopper, the slitter extrudes the material to the slitter, the slitter rotates to cut the material, and the material is dried in the box. With the rotation of the mesh belt, from the upper mesh belt to the lower mesh belt, to the discharge hopper, and finally the dried material is output by the discharge machine.

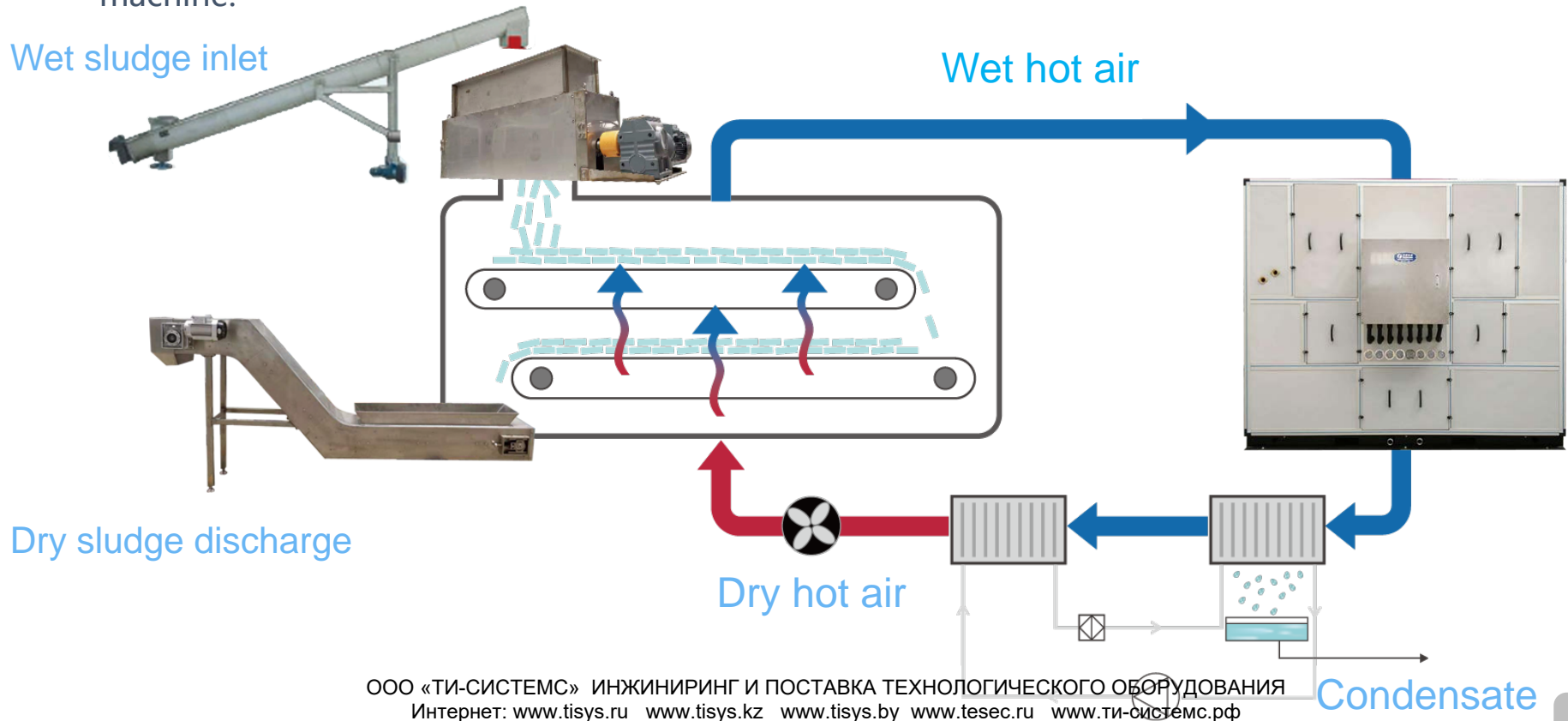

► Slitter

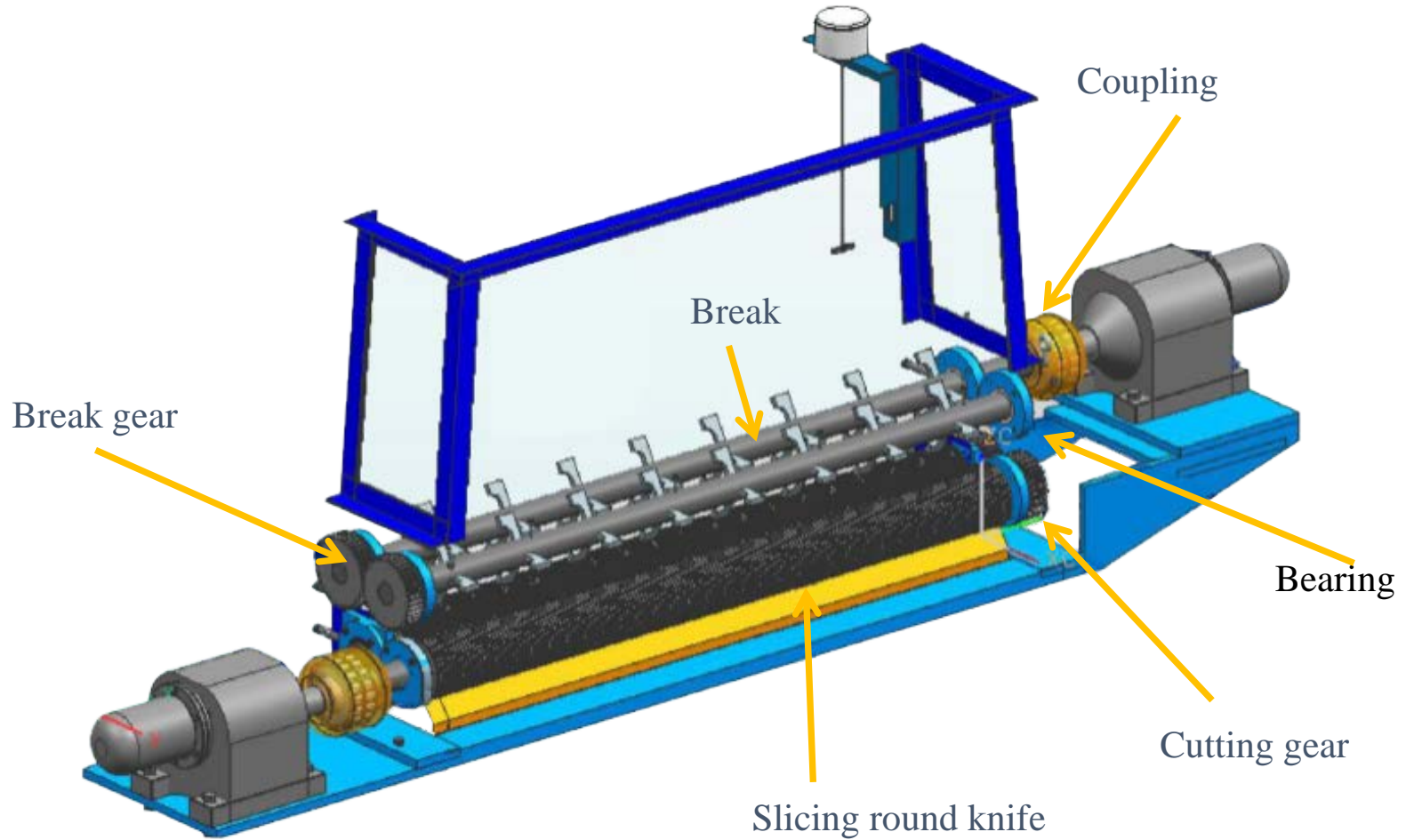

Air circle

The air duct system consists of a blower, a filter, and a heat exchanger. After the lower mesh belt, the upper mesh belt, the water coil, the condenser and the evaporator to form a closed inner circulation air duct, they are connected in sequence: 1. (Blower → lower mesh belt → upper mesh belt → filter screen → water coil → heat exchanger → evaporator → heat exchanger → condenser → blower)
2. (circulating fan → upper mesh belt → primary condenser → upper circulating fan).

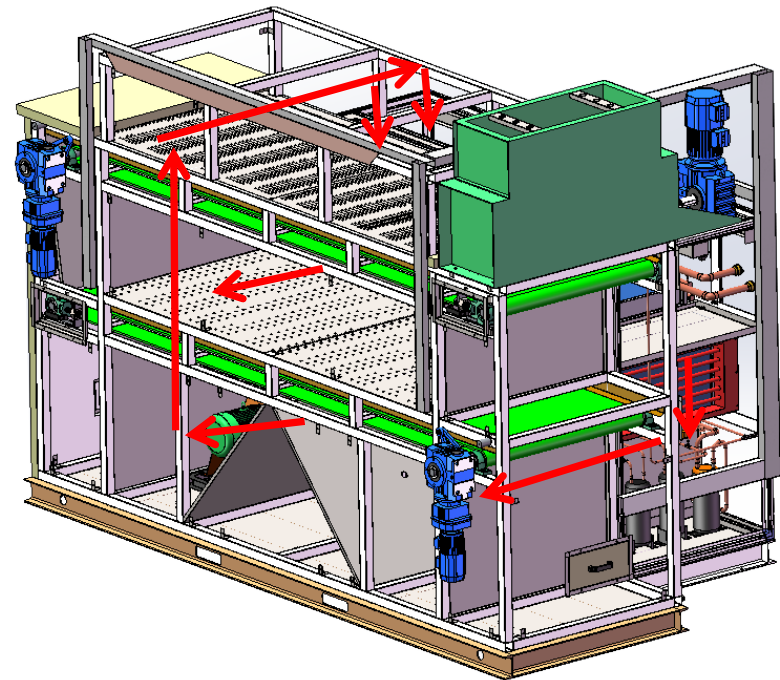
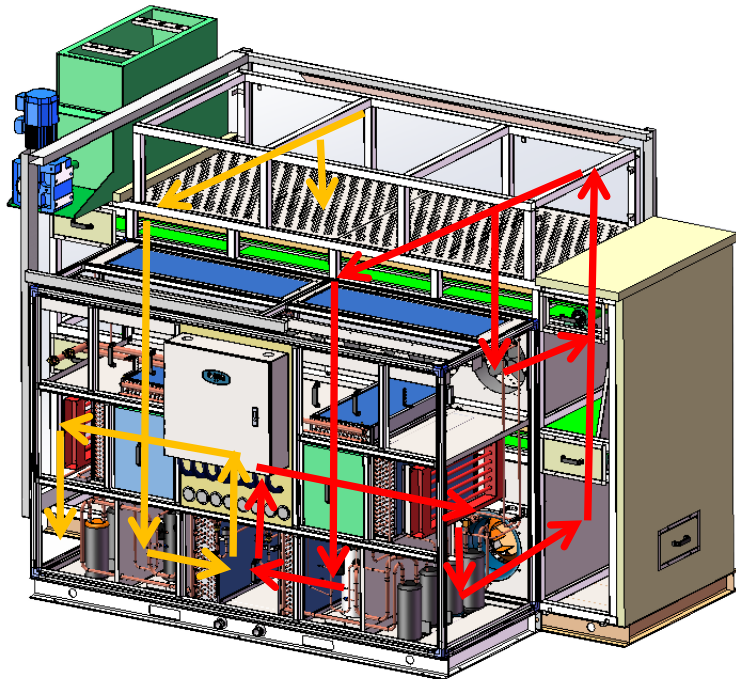

Cooling system

The main function of the cooling system is to dissipate excess heat in time to ensure that the dryer works normally under the set temperature state. The cooling system is divided into water-cooled and air-cooled according to the different cooling medium. The water-cooled type uses water as the cooling medium, and transfers the excess heat to the water first, and then dissipates it into the atmosphere. The air-cooled type uses air as the cooling medium and dissipates the heat directly into the atmosphere. The return air of each module of the dryer is the cooling object, and the cooling system is turned on according to the set return air temperature, and then the opening degree of cooling is automatically adjusted according to the change of the temperature difference.

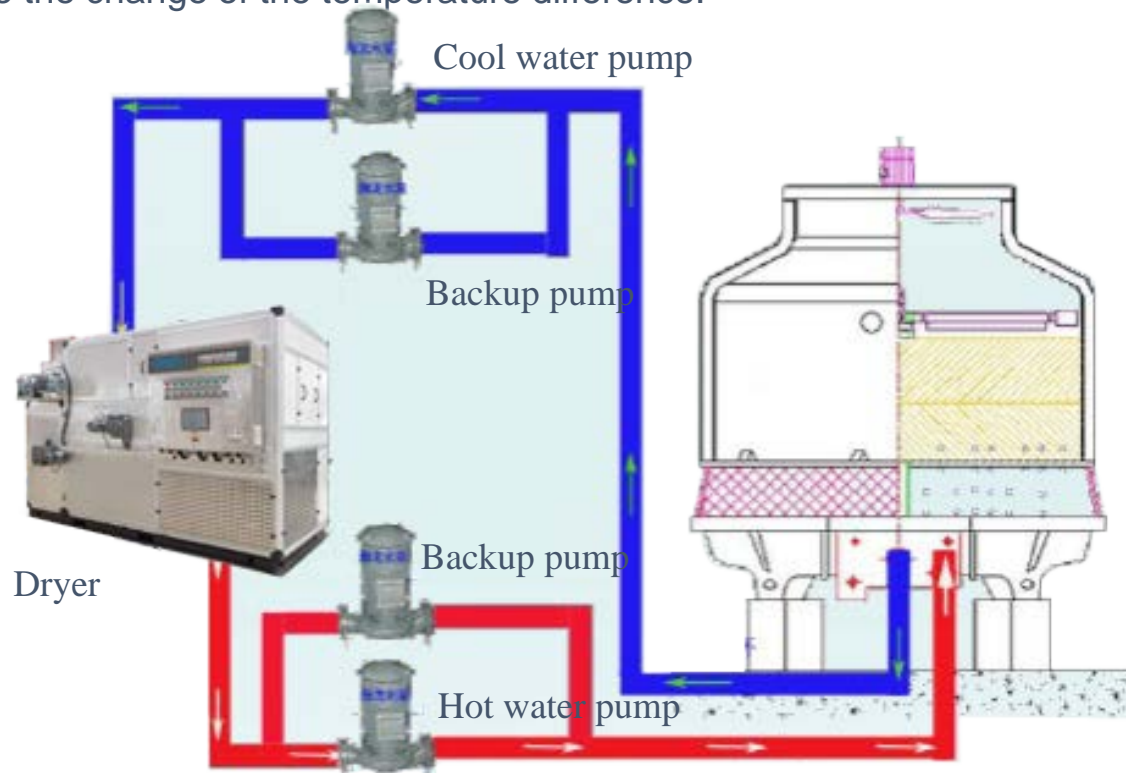

Control Panel

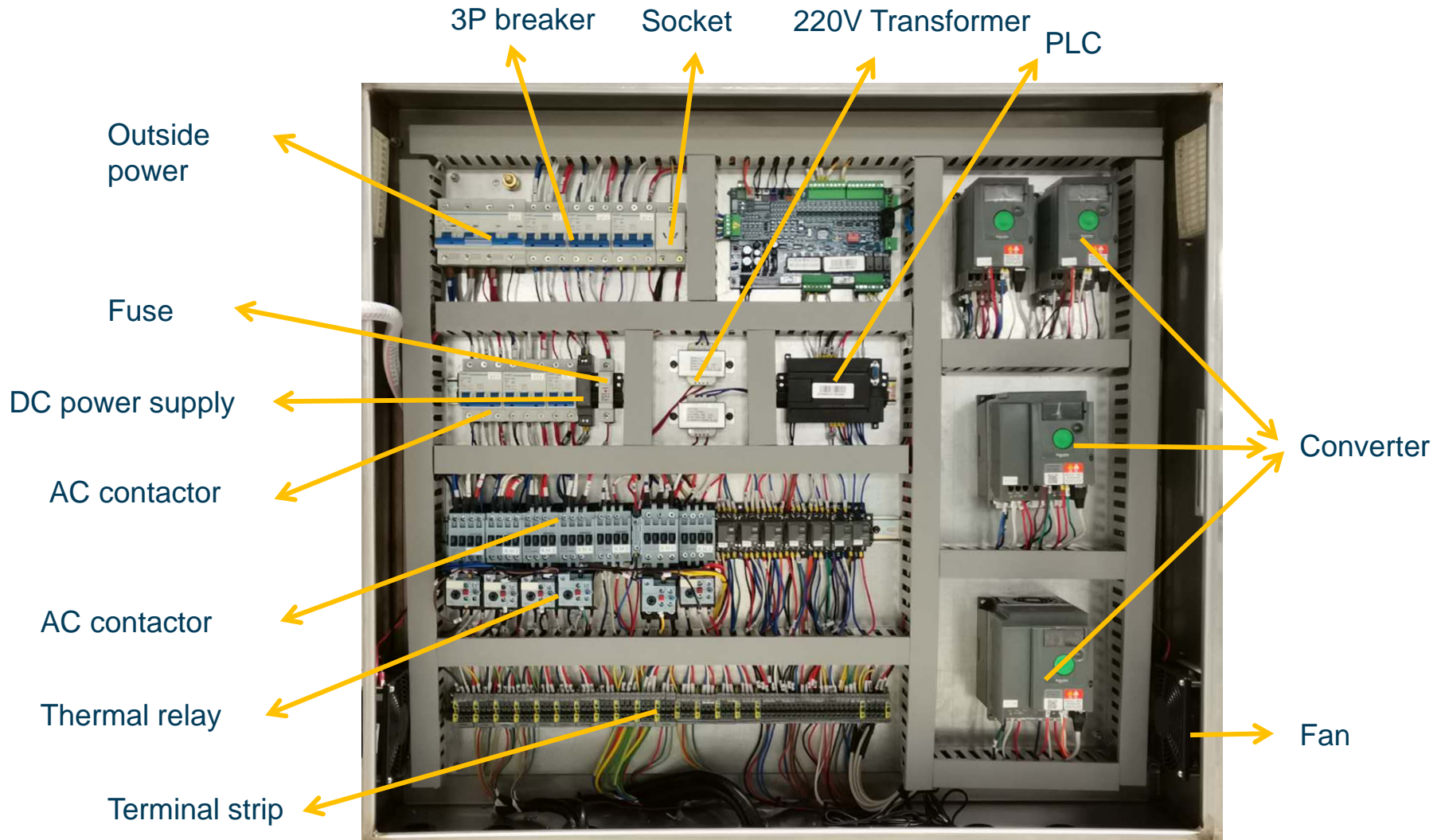

Details

▶ Anti corrosion, and easy maintenance

Overall anti-corrosion

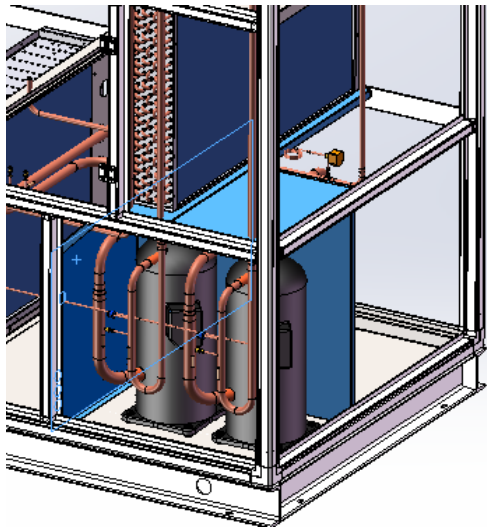

Anti corrosion materials combined with the isolation technology of perishable parts are used for comprehensive anti-corrosion and durability.

Easy maintenance



The structure layout is reasonable and the maintenance is more convenient.

► Welding



Welding of brass liquid distributor assembly



Bending and positioning distribution pipe



Menu

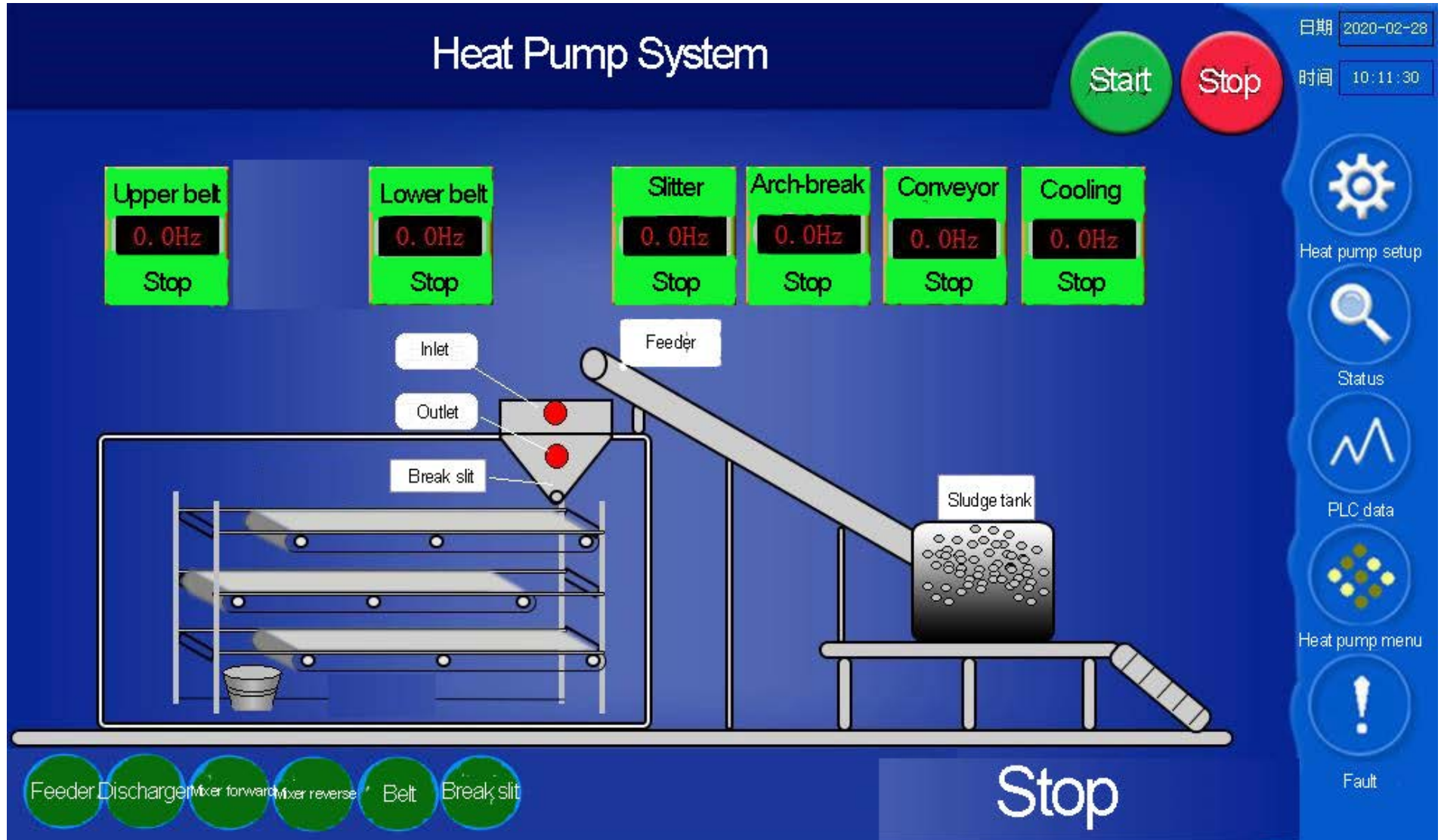

The interface displays the following components and controls:

- System Title:** Heat Pump System
- Date:** 2020-02-28
- Time:** 10:11:30
- Control Buttons:** Start (green), Stop (red)
- Motor Status Panels:**
 - Upper belt: 0.0Hz, Stop
 - Lower belt: 0.0Hz, Stop
 - Slitter: 0.0Hz, Stop
 - Arch-break: 0.0Hz, Stop
 - Conveyor: 0.0Hz, Stop
 - Cooling: 0.0Hz, Stop
- Process Diagram:** Shows the material flow from Inlet through a Feeder, Break slit, and Sludge tank.
- Bottom Control Row:** Feeder, Discharge, Mixer forward, Mixer reverse, Belt, Break slit, and a large Stop button.
- Right Sidebar:** Heat pump setup (gear icon), Status (magnifying glass icon), PLC data (line graph icon), Heat pump menu (dots icon), and Fault (exclamation mark icon).

Sludge drying process and related components

Front dewatering machine → feeding device → wet silo → feeding device →
slitter → sludge dryer → discharge device

Accessory: Cooling tower, Heat exchange

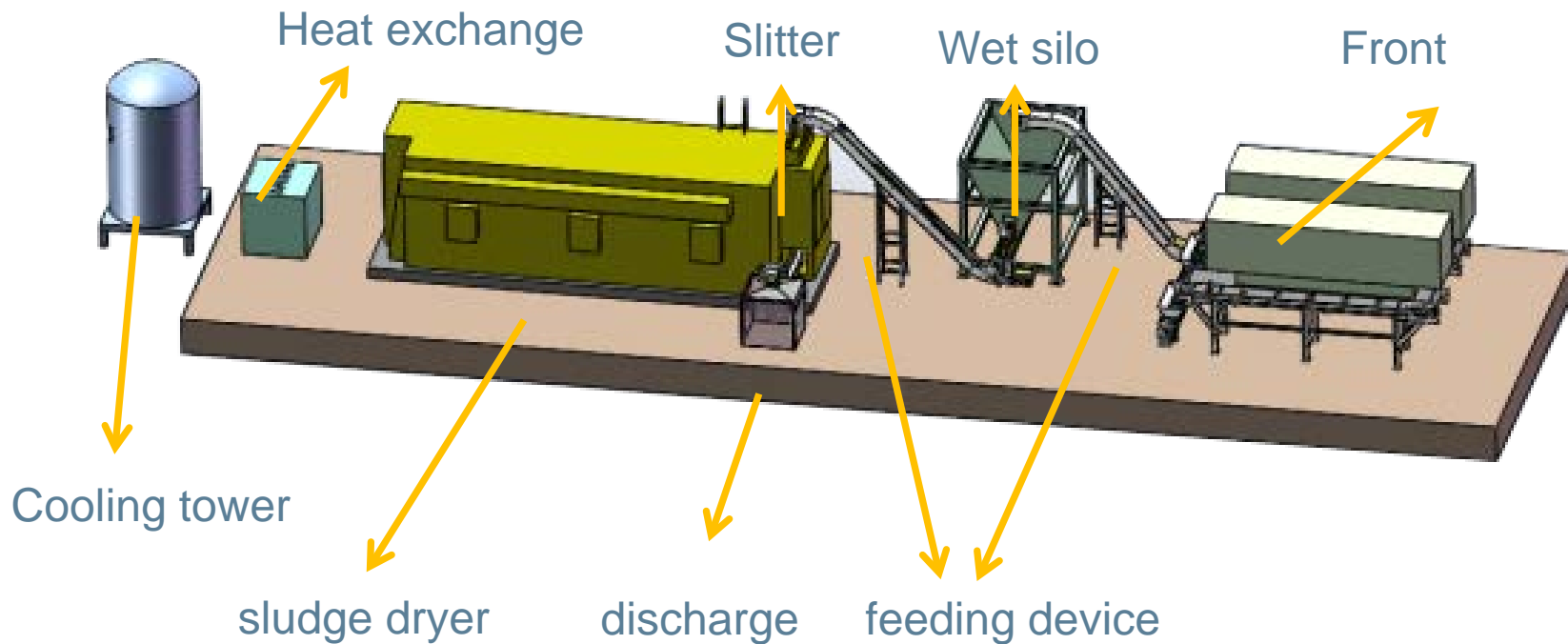



THANKS

ООО «ТИ-СИСТЕМС» ИНЖИНИРИНГ И ПОСТАВКА ТЕХНОЛОГИЧЕСКОГО ОБОРУДОВАНИЯ
Интернет: www.tisys.ru www.tisys.kz www.tisys.by www.tesec.ru www.ти-системс.рф
Телефоны: +7 (495) 7774788, 7489626, (925) 5007155, 54, 65
Эл. почта: info@tisys.ru info@tisys.kz info@tisys.by